



NEXT GENERATION DIE & MOLD
MACHINING CENTER

MD

6700



DN SOLUTIONS

MD 6700

The new DN Solutions MD 6700 Die & Mold vertical machining center delivers high performance, increased accuracies and unrivalled reliability.

To ensure and optimize stability and precision, functions such as thermal compensation and spindle and ball screw cooling are all included as standard. In addition, the MD 6700, despite its compact footprint has a large working envelope and provides the ultimate solution for Die and Mold applications.



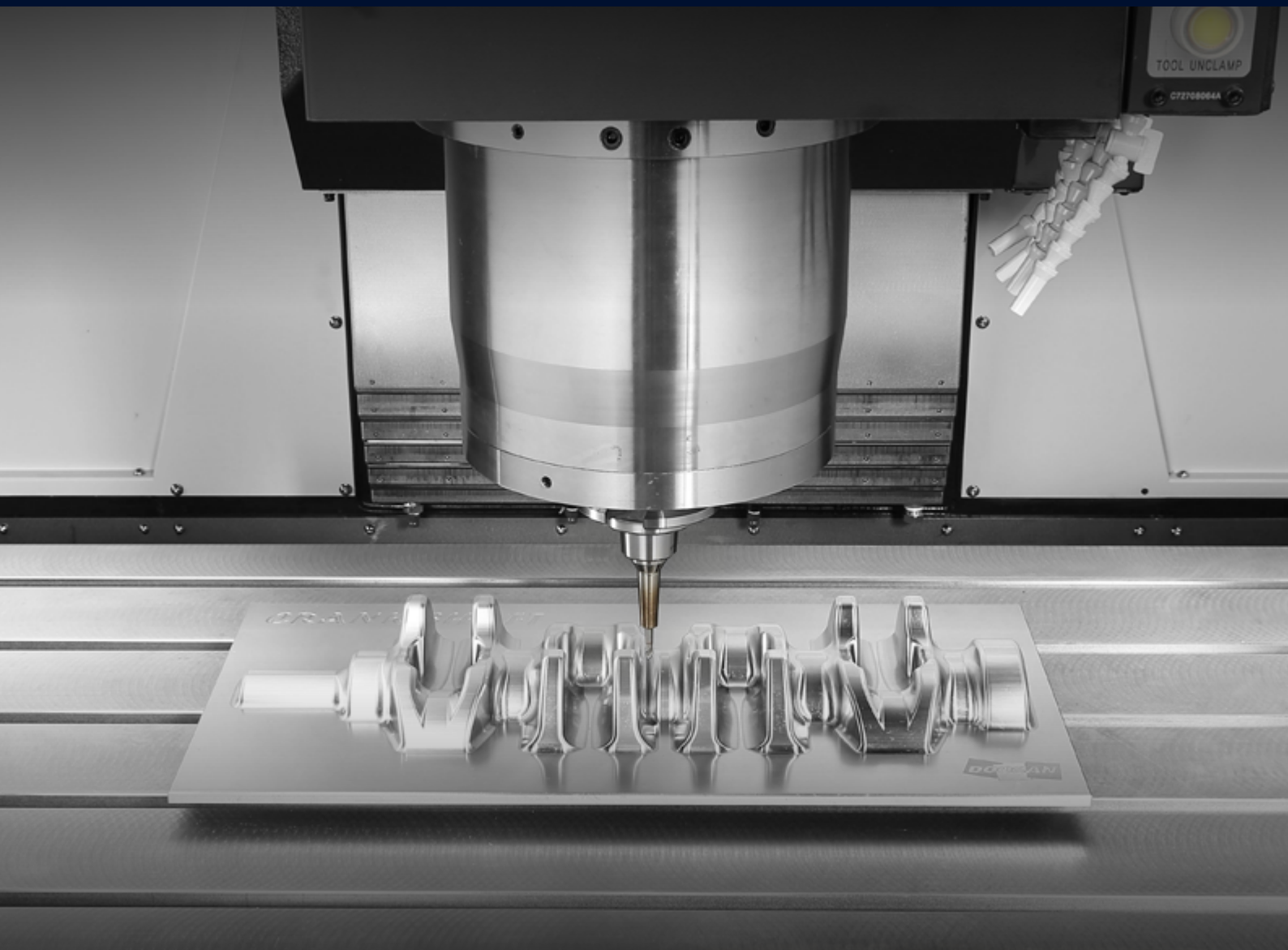

HIGH PRODUCTIVITY SPECIFICATION

- For maximum productivity, a range of different spindle and servo-driven tool magazine options are available.
- High-speed built-in type spindles
- High-torque gear driven spindles for heavy duty cutting - (8000 r/min - 958 N-m).

HIGH PRECISION MACHINING

- A Y-axis hybrid guideway structure (Box and LMG) is applied to improve accuracy.
- Spindle and structural thermal compensation together with spindle and ball screw shaft cooling systems are included as standard.

COMPACT AND HIGHLY RIGID STRUCTURE

- Small machine footprint
- Machine structure is made from a highly rigid grade of cast iron

BASIC STRUCTURE

The machines, with their highly rigid castings and optimized structural design and build, are incredibly stable.

Travel distance

X axis **1300** mm 51.2 inch
Y axis **670** mm 26.4 inch
Z axis **670** mm 26.4 inch

Rapid traverse rate

X axis **24** m/min 944.9 ipm
Y axis **24** m/min 944.9 ipm
Z axis **24** m/min 944.9 ipm

Ultimate precision is ensured via the incorporation of standard features that include:

- Cooling system (spindle and ball screw assembly)
- Spindle and structural thermal compensation system

Table

Maximizing cutting area & work load capacity.

Table size (A x B)

1500 x 670 mm
59.1 x 26.4 inch

Table load capacity

2000 kg
4409.2 lb

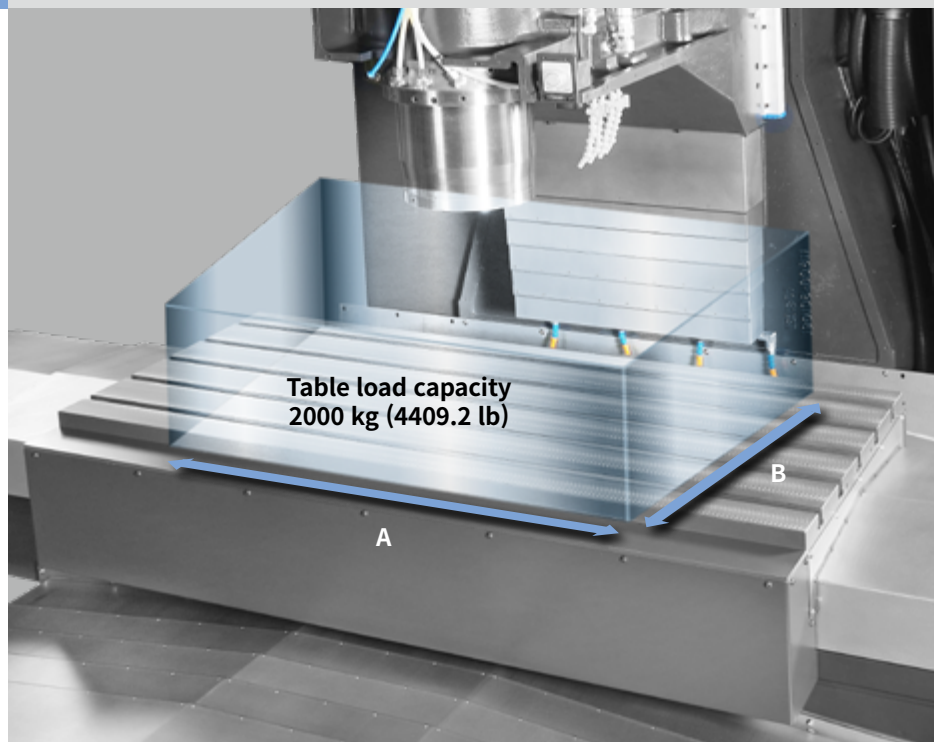

SPINDLE | MAGAZINE

To satisfy different machining requirements, both built-in and gearbox spindle options are available.

Max. spindle speed

12000 r/min

8000 r/min option

Max. spindle motor power

30 kW / **30** kW option

40.2 Hp / 40.2 Hp

Max. spindle motor torque

420 N·m / **958** N·m option

310 ft-lbs / 707 ft-lbs

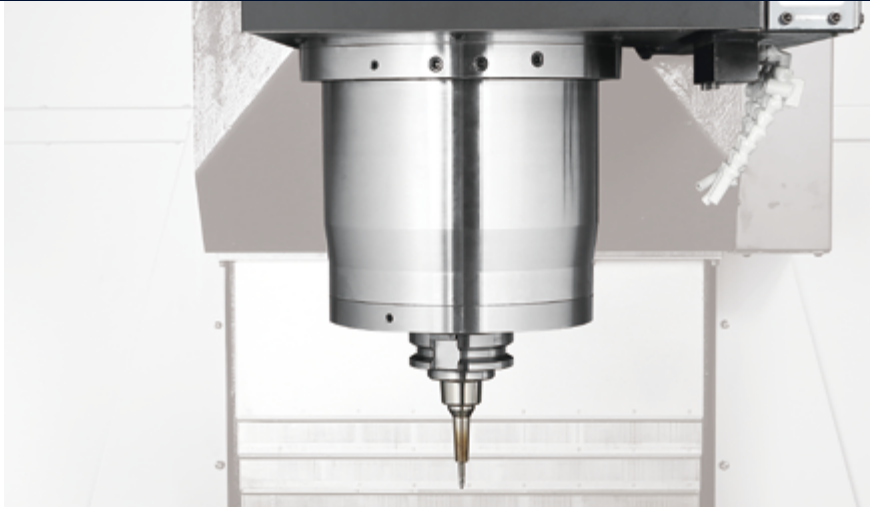

The MD 6700 can be supplied with a built-in spindle with a static pressure structure that improves cutting performance (roughing and finishing) to ensure best in-class mold machining.

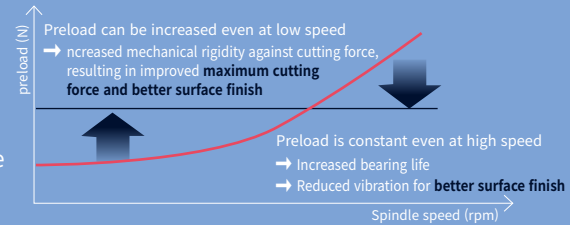

Cutting Performance

The MD 6700 delivers the best cutting performance in its class to optimize productivity.

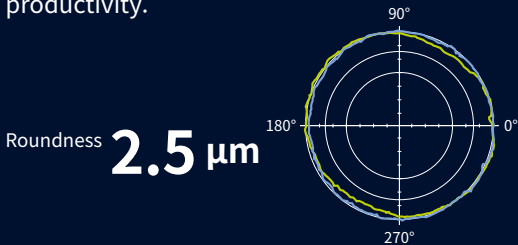

High Productivity

Engine Cover



Material	HP4M
Options	TS27R, MQL, MOLD Package
Run hours	37 hours
Cutting conditions	<ul style="list-style-type: none"> • 10 mm ball endmill • Spindle speed 6200 r/min • Feedrate 1500 mm/min

* The results, indicated in this catalogue, are provided as examples only. They may not always be achieved owing to different cutting and environmental conditions.

Magazine

Servo-type tool magazines are included as standard for high productivity and reliability.

Tool storage capacity

24 ea / **30** ea option

T-T-T | C-T-C

2.7 sec | **4.7** sec



24 ea

* Servo-type tool magazine ensures machining stability when changing tools during machining.

STANDARD | OPTIONAL SPECIFICATIONS

A range of options is available to suit individual requirements.

Description	Features		MD 6700
Spindle	12000 r/min (Built in)	30 kW (40.2 Hp), 420 N·m (310 ft-lbs)	●
	8000 r/min (Gear Box)	30 kW (40.2 Hp), 958 N·m (707 ft-lbs)	○
Tool shank type	BIG PLUS BT50		●
	BIG PLUS CAT50		○
	BIG PLUS DIN50		○
Magazine	Tool storage capacity	24 ea	●
		30 ea	○
Coolant	FLOOD	0.4 KW-0.15 MPA-40 L/MIN	●
		1.1 KW-0.45 MPA-30 L/MIN	○
		1.8 KW-0.7 MPA-30 L/MIN	○
	TSC	None	●
		1.5 KW-2.0 MPA	○
		4.0 KW-2.0 MPA	○
		1.5 KW-3.0 MPA-COOLJET BAG	○
		5.5 KW-7.0 MPA-DUAL BAG	○
	SHOWER		○
	Coolant level switch : Sensing level - Low / High**		○
Chip disposal	Chip conveyor	Chip pan	●
		HINGED BELT TYPE or MAGNETIC SCRAPER TYPE	○
	Chip bucket	Forklift type / 300	○
		Rotary type / 300	○
	Air gun		○
Coolant gun		○	
Precision machining option	Linear scale	X / Y / Z axis	○
	DSQ1 (AICC II_200 BLOCKS)		●
	DSQ2 (DSQ1 & DATA SERVER 1GB)		○
	DSQ3 (DSQ2 & 600 BLOCKS)		○
	DSQ4 (DSQ3 & 1000 BLOCKS)		○
Measurement & Automation	Automatic tool measurement	TS27R-RENISHAW	○
		OTS-RENISHAW	○
		NC4-RENISHAW	○
	Automatic front door with safety device	OMP60-RENISHAW	○
Others	LED Work light		●
	3 Color signal tower		●
	EZ Guide i		○
	WORK & TOOL COUNTER		○
Customized Special Option	ATC AUTO SHUTTER		○
	ANCHORING	J-BOLT	○
	COOLANT CHILLER		○
	AUTO TOOL BREAKAGE DETECTION	MAKER/SPEC.-OMRON / D5A	○
		MAKER/SPEC.-NEEDLE	○
	4TH AXIS PREPARATION CABLING FOR SERVO/1-PNEUMATIC PIPING	FACTORY READY MADE	○
	4TH AXIS WITH CNC R.TABLE	AVAILABLE SIZE-Φ500	○
		SERVO MOTOR: DEPENDS ON THE TABLE	○
	5TH AXIS	AVAILABLE SIZE-USER DEFINED	○
		SERVO MOTOR-USER DEFINED	○
HARD-TO-CUT MATERIAL CUTTING PACKAGE		X/Y-Axis Power-Up, Middle Pressure Flood Coolant, High Torque Gear Driven Spindle	○

*Please contact DN Solutions for detailed specifications. **Special Quotation.

● Standard ○ Optional x Not applicable

PERIPHERAL EQUIPMENT

Hard-to-cut Material Cutting Package

We offer a high-torque gearbox spindle and a highly rigid machine structure to optimize the machining of difficult materials such as Titanium and Inconel (used in the Aerospace and Oil/Gas sectors), as well as traditional Die & Mold materials.

Coolant(Amount, pressure)

25% Improved

Cutting(depth)

50% Improved

Spindle torque

— Standard — Difficult cut

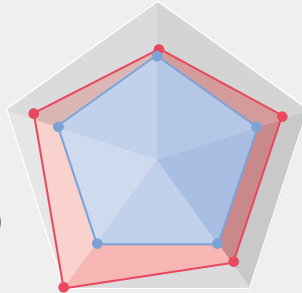

Axis rigidity

23% Improved

Axis thrust

20% Improved

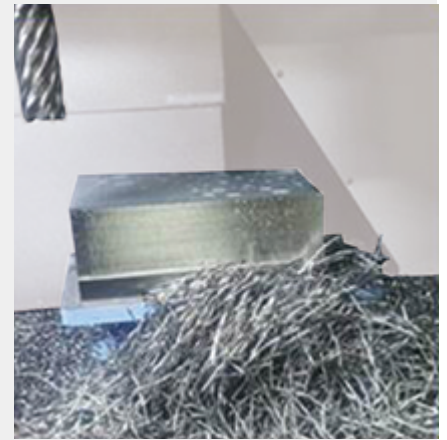

Material : Titanium

* The results are provided as examples only and may not be obtained due to differences in prevailing cutting and environmental conditions.

Peripheral equipment

Tool measuring device option

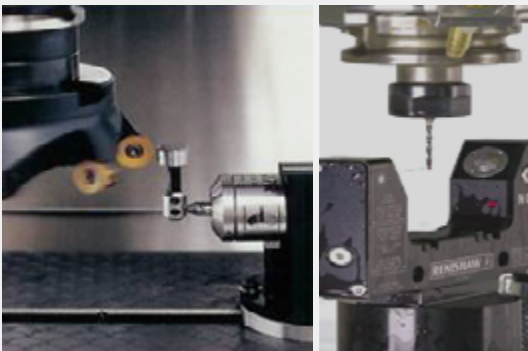

TS27R

NC4

Chip bucket option

Capacity **300L**
79.3 gal



Linear scale option



Servo magazine

Tool **30ea** option

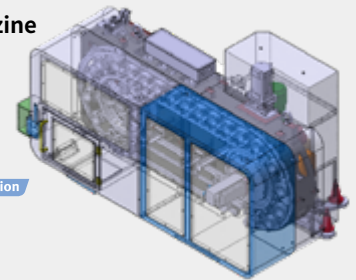

Chip conveyor option

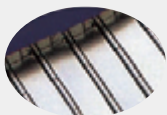

Hinged belt

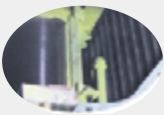

Magnetic scraper



Long



Needle

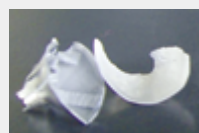

Short

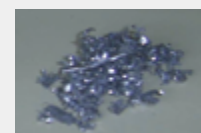

Sludge

Chip conveyor type	Material			Carbon steel		Cast iron		Aluminium		
	Long	Short	Needle	Short	Sludge	Long	Short	Needle		
Hinged belt type	○	△	X	△	X	○	△	X		
Scraper type	X	○	△	○	△	X	○	△		

○ : Suitable, △ : Possible, X : Not suitable

OPTIMIZED TOOL PROCESSING SOLUTION

Superior surface finishes and superior machining precision are achieved by using standard DN Solutions processing solutions, such as high speed / high precision contour control and thermal displacement compensation functions.

High Speed / High Precision Contour Control

- **DSQ1** (AICC2 _ 200 Block + Machining condition selection function)
- **DSQ2** option (DSQ1 + Data server [1GB])
- **DSQ3** option (DSQ2 + High speed processing _ 600 Block)



*DSQ : DN Solutions Super Quality

Tool Load Monitoring System (DTMM*)

The technology that protects the tool and machine when machining abnormal loads.

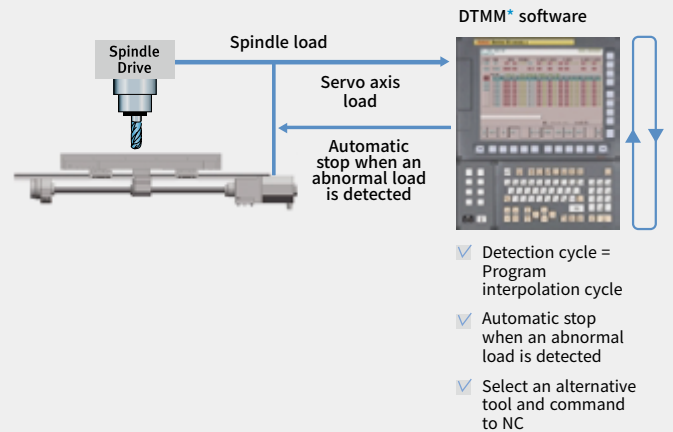

*DTMM : DN Solutions Tool load Monitoring for Machining Centers

The Optimal Feed Control (DAFC*)

Optimal feed control is ensured by spindle load detection that occurs in real time.

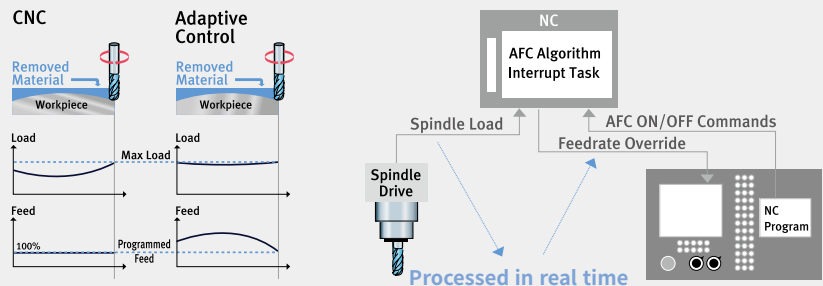

*DAFC : DN Solutions Adaptive Feedrate Control

Smart, multi-compensation thermal displacement technology

Realization of high-quality, high-precision machining achieved by thermal compensation of the spindle and machine structure.

Compensation of static spindle displacement

Compensates for changes in tool position caused by expansion of the spindle shaft during high speed operations.

Structural thermal displacement compensation

Compensates for any irregular deflection or expansion of the structure due to ambient temperature fluctuation by using multiple temperature sensors.

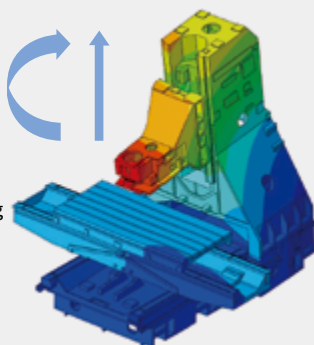

Thermal displacement compensation structure

Thermal displacement of the spindle, caused by heat accumulation, is compensated for using 5 algorithms including a smoothing function.

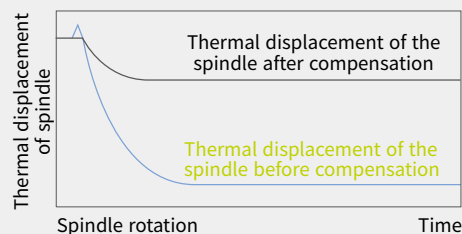
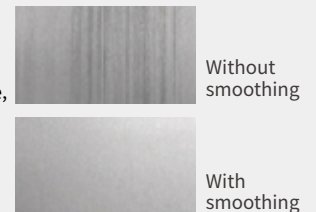

FANUC 31i/32i PLUS

Fanuc i Plus maximizes customer productivity and convenience.

15" Touch screen + New OP

DN Solutions Fanuc 31iB/B5 Plus' operation panel enhances operating convenience by incorporating common-design buttons and layout. It features a Qwerty keyboard for fast and easy data input and operation.

Fanuc 31i/32i Plus

- 15-inch color display
- Intuitive and user-friendly design

USB and PCMCIA card QWERTY keyboard

- EZ-Guide i standard
- Ergonomic operator panel
- 4MB Memory
- Hot keys
- Enhance AICC BLOCK
- Touch pen provided as standard



iHMI touchscreen

iHMI provides an intuitive interface that uses a touchscreen for quick and easy operation.

Range of applications

Providing various applications related to planning, machining, improvement and utility, for customer convenience.

NUMERIC CONTROL SPECIFICATIONS

FANUC

Item	Specifications	F31iB Plus MD 6700
Controlled axis	Controlled axes	5 (X,Y,Z)
	Simultaneously controlled axes	5 axes
	Additional controlled Axis	●
Data input/output	Fast data server	○
	Memory card input/output	●
	USB memory input/output	●
	Large capacity memory(2GB)*2	○
Interface function	Embedded Ethernet	●
	Fast Ethernet	○
	Enhanced Embedded Ethernet function	●
Operation	DNC operation	Included in RS232C interface. ●
	DNC operation with memory card	●
Program input	Workpiece coordinate system	G52 - G59 ●
	Addition of workpiece coordinate system	G54.1 P1 X 48 (48 pairs) ●
	Tool number command	T4 digits
	Tilted working plane indexing command	G68.2 TWP ○
Feed function	AI contour control I	G5.1 Q_, 40 Blocks X
	AI contour control II	G5.1 Q_, 200 Blocks X
	AI contour control II	G5.1 Q_, 600 Blocks X
	AI contour control II	G5.1 Q_, 1000 Blocks *1) ●
	High smooth TCP	X
Operation guidance function	EZ Guidei (Conversational Programming Solution)	●
	iHMI with Machining Cycle	Only with 15" Touch LCD standard *2) X
	EZ Operation package	●
Setting and display	CNC screen dual display function	●
	FANUC MTConnect	⊕
Network	FANUC OPC UA	⊕
	Others	Display unit
		15" color LCD X
		15" color LCD with Touch Panel ●
		640M(256KB)_500 programs X
		1280M(512KB)_1000 programs ○
		2560M(1MB)_1000 programs ○
		5120M(2MB)_1000 programs ○
		10240M(4MB)_1000 programs ●
		20480M(8MB)_1000 programs ○
		2560M(1MB)_2000 programs ○
		5120M(2MB)_4000 programs ○
		10240M(4MB)_4000 programs ○
		20480M(8MB)_4000 programs ○

*1) The number of look-ahead blocks may be changed or limited depending on the peripheral device or the configuration of the internal NC system.

*2) Available Option only with Fanuc i plus iHMI

● Standard ○ Optional X N/A ⊕ Available
Network: FANUC MT Connect and FANUC OPC UA available.

EZ WORK

The software developed by DN Solutions features numerous functions designed for convenience and ease of operation.

EZ work

The EZ work delivers speed and efficiency. This menu-driven innovation not only helps customers reduce setup times, but also simplifies common tasks and procedures, reducing the potential for errors. EZ work reduces operating time, protects machinery, enhances quality and speeds up maintenance interventions.



Thermal Compensation

A function to maintain high-precision machining quality by analyzing and correcting the amount of thermal displacement of a structure through a temperature sensor



M/G-Code List

Functional description of M code and G code



Tool Management

Function to manage tool information [Tool information / Tool No. / Tool condition (normal, large diameter, worn / damaged, used for the 1st time, manual) / Tool name]

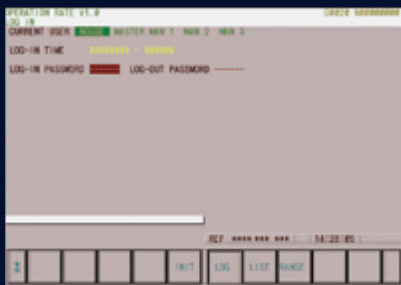

Operation Rate

Machine operation history management function by date based on load



Adaptive Feed Control

Function to control feedrate so that the cutting can be carried out at a constant load (To adapt to the spindle load set up with constant load feedrate control function)



Spindle Warm Up

A function that assists spindle warm-up for spindle life when the spindle has not been used for a certain period of time



ATC Recovery

Function to view detailed info with recommended actions and to perform step-by-step operation manually (when an alarm is triggered during an ATC operation)

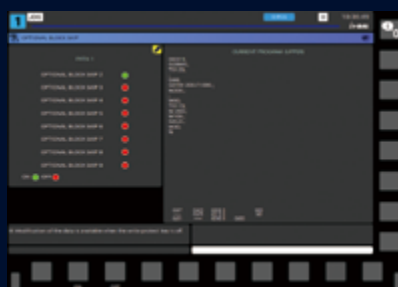

Addition of Optional Block Skip

In addition to the OPTIONAL BLOCK SKIP of the operation panel, the function to skip a specific block selected in the machining program

POWER | TORQUE

8000 r/min

MAX. SPINDLE SPEED: **8000** r/min

MAX. SPINDLE TORQUE: **30** kW
40.2 Hp

MAX. SPINDLE POWER: **958** N·m
707 ft-lbs

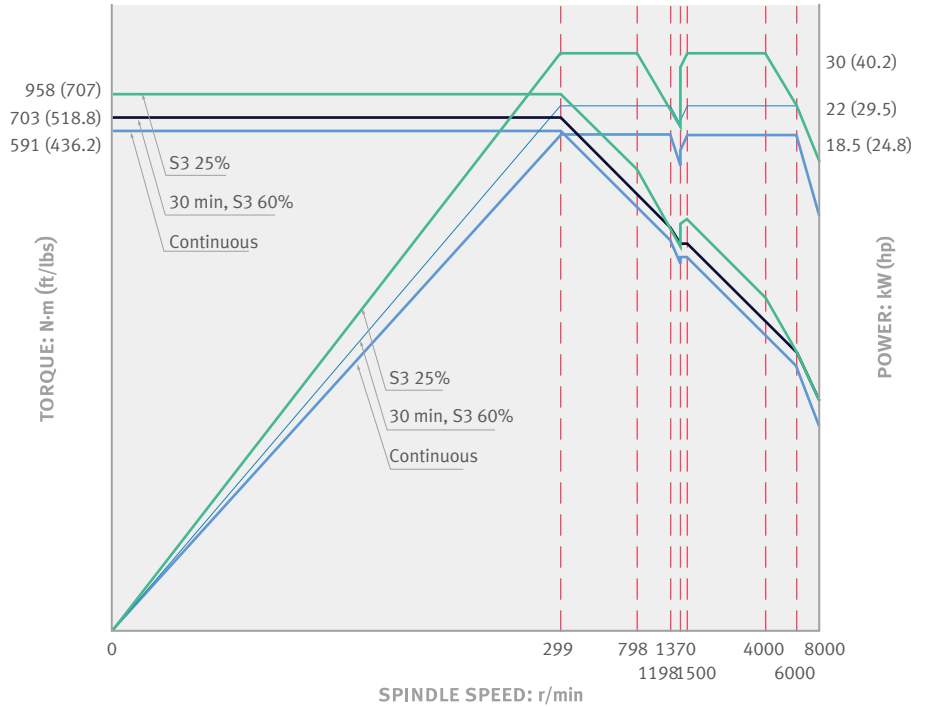

12000 r/min

MAX. SPINDLE SPEED: **12000** r/min

MAX. SPINDLE TORQUE: **30** kW
40.2 Hp

MAX. SPINDLE POWER: **420** N·m
310 ft-lbs

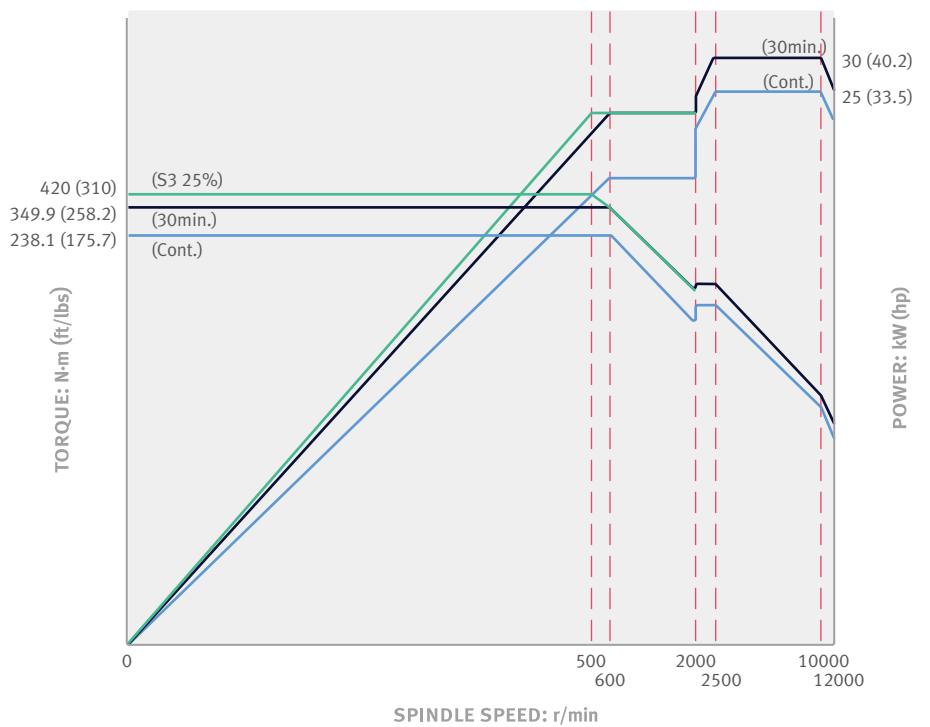

DIMENSIONS

Units : mm (inch)

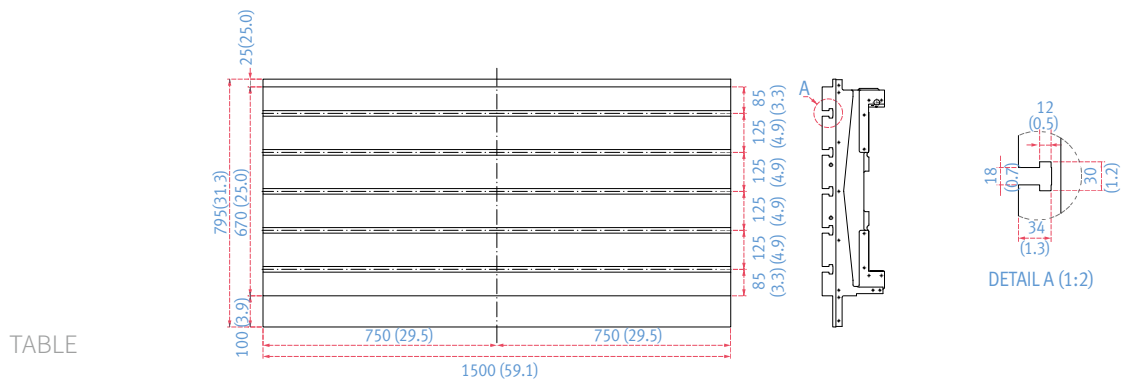
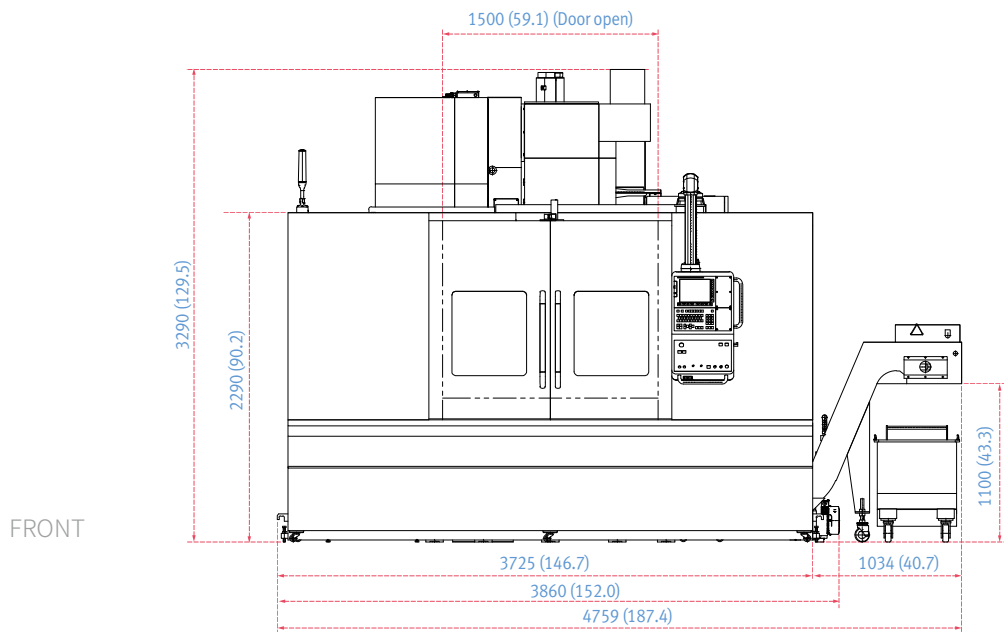
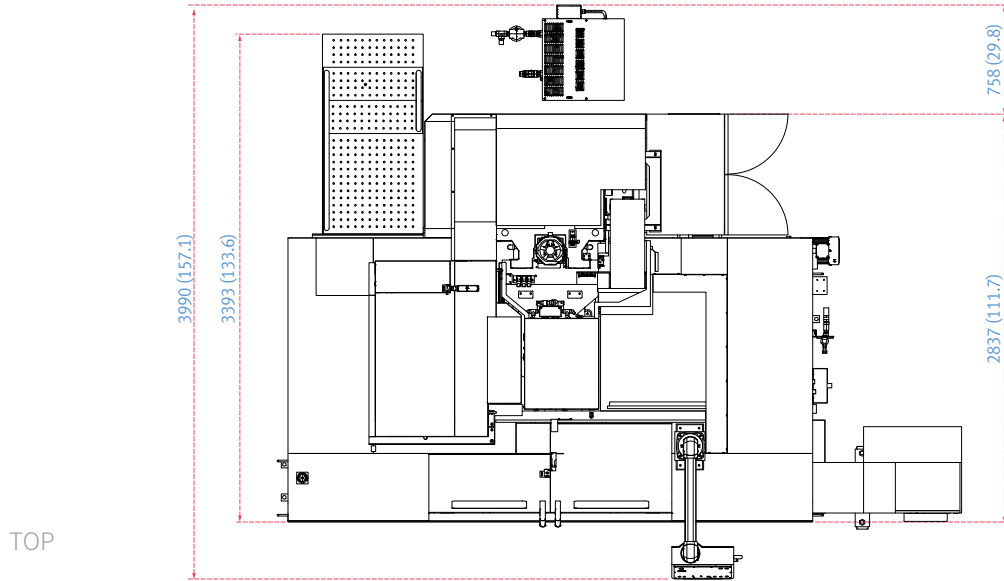

* Some peripheral equipment can be placed in other areas.

MACHINE SPECIFICATIONS

Description			Unit	MD 6700
Travel	Travel distance	X-axis	mm (inch)	1300 (51.2)
		Y-axis	mm (inch)	670 (26.4)
		Z-axis	mm (inch)	670 (26.4)
	Distance from spindle nose to table top		mm (inch)	200 ~ 870 (7.9 ~ 34.3)
Table	Table size		mm (inch)	1500 x 670 (59.1 x 26.4)
	Tool storage capacity		kg (lb)	2000 (4409.2)
Spindle	Max. spindle speed		r/min	12000 {8000}*
	Taper		-	ISO #50
	Max. Spindle power		kW (Hp)	30 {30}* (40.2 {40.2})
	Max. spindle torque		N · m (ft-lbs)	420 {958}* (310 {707})
Feedrate	Rapid traverse rate	X-axis	m/min (ipm)	24 (944.9)
		Y-axis	m/min (ipm)	24 (944.9)
		Z-axis	m/min (ipm)	24 (944.9)
Automatic Tool Changer (ATC)	Tool storage capa.		ea	24 {30}*
	Max. tool diameter	Continuous	mm (inch)	125 (4.9)
		Without Adjacent Tools	mm (inch)	230 (9.1)
	Max. tool length		mm (inch)	400 (15.7)
	Max. tool weight		kg (lb)	20 (44.1)
	Tool change time (Tool-to-tool)		sec	2.7
Machine Dimensions	Height		mm (inch)	3290 (129.5)
	Length		mm (inch)	3990 (157.1)
	Width		mm (inch)	3860 (152.0)
	Weight		kg (lb)	12000 (26455.1)
Control	CNC system		-	F31iB Plus

* { } : Option

The DN Solutions promise, MACHINE GREATNESS, has two important meanings. The first is simple: DN Solutions makes great machines. The second is a challenge to our end-users. With a product line that is this comprehensive, accurate and reliable, we equip our customers to machine greatness. The big question: **Why should you choose DN Solutions over other options?**

Here's why...



**MACHINE
GREATNESS™**



WHAT YOU MAKE AND HOW YOU MAKE IT MATTERS—SO MAKE IT
GREAT WITH DN SOLUTIONS.

UNBEATABLE MACHINES

You won't find a more comprehensive range or a better combination of value, performance and reliability anywhere else.

ROBUST PRODUCT LINE

We offer an impressive range of machine models and hundreds of configurations. Whatever your machining needs and requirements, there's a DN Solutions for you.

READILY AVAILABLE - ANYWHERE IN THE WORLD

Machining centres (including 5-axis machines), lathes, multi-tasking turning centres and mill-turn machines, and horizontal borers with best-in-class specifications are all available...ready to install.

EXPERT SERVICE

Our dedicated, experienced and knowledgeable team is totally committed to improving your productivity, growth and success.

RESPONDING TO CUSTOMERS ANYTIME, ANYWHERE

DN Solutions Global Network

DN Solutions provides systems-based professional support services, before and after the machine tool sale, by responding quickly and efficiently to customers. By supplying spare parts, product training, field service and technical support, we provide the expert care, attention and assistance our customers expect from a market leader.

Global sales and service support network		51	Technical centers Technical center, Sales support, Service support, Parts support
4	Corporations	200	Service posts
155	Dealer networks	3	Factories



CUSTOMER SUPPORT AND SERVICES

We're there for you whenever you need us.

We help our customers operate at maximum efficiency by providing them with a range of tried, tested and trusted services - from pre-sales consultancy to post-sales support.



Field services

- On-site service
- Machine installation and testing
- Scheduled preventive maintenance
- Machine repair service



Parts supply

- Supplying a wide range of original DN Solutions spare parts
- Parts repair service



Training

- Programming, machine setup and operation
- Electrical and mechanical maintenance
- Applications engineering



Technical support

- Supports machining methods and technology
- Responds to technical queries
- Provides technical consultancy



dn-solutions.com

Head Office

22F T Tower, 30, Sowol-ro 2-gil
Jung-gu, Seoul, Korea, 04637

Tel: +82-2-6972-0370/0350
Fax: +82-2-6972-0400

DN Solutions America

19A Chapin Road, Pine Brook
New Jersey 07058, United States

Tel: +1-973-618-2500
Fax: +1-973-618-2501

DN Solutions Europe

Emdener Strasse 24, D-41540
Dormagen, Germany

Tel: +49-2133-5067-100
Fax: +49-2133-5067-111

DN Solutions India

No.82, Jakkuar Village
Yelahanka Hobli, Bangalore-560064

Tel: + 91-80-2205-6900
E-mail: india@dncompany.com

DN Solutions China

Room 101,201,301, Building 39 Xinzhuan
Highway No.258 Songjiang District
China Shanghai (201612)

Tel: +86 21-5445-1155
Fax: +86 21-6405-1472

Sales inquiry

sales@dncompany.com

* For more details, please contact DN Solutions.

* Specifications and information contained within this catalogue may be changed without prior notice.